

# **nanoNET Chirp Based Wireless Networks**

White Paper

Version 1.04

NA-04-0000-0298-1.04



Chirp it.

**Document Information**

Document Title: nanoNET Chirp Based Wireless Networks  
Document Version: 1.04  
Published (yyyy-mm-dd): 2007-02-20  
Current Printing: 2007-2-20, 12:31 pm  
Document ID: NA-04-0000-0298-1.04  
Document Status: Released

**Disclaimer**

Nanotron Technologies GmbH believes the information contained herein is correct and accurate at the time of release. Nanotron Technologies GmbH reserves the right to make changes without further notice to the product to improve reliability, function or design. Nanotron Technologies GmbH does not assume any liability or responsibility arising out of this product, as well as any application or circuits described herein, neither does it convey any license under its patent rights.

As far as possible, significant changes to product specifications and functionality will be provided in product specific Errata sheets, or in new versions of this document. Customers are encouraged to check the Nanotron website for the most recent updates on products.

**Trademarks**

nanoNET® is a registered trademark of Nanotron Technologies GmbH. All other trademarks, registered trademarks, and product names are the sole property of their respective owners.

This document and the information contained herein is the subject of copyright and intellectual property rights under international convention. All rights reserved. No part of this document may be reproduced, stored in a retrieval system, or transmitted in any form by any means, electronic, mechanical or optical, in whole or in part, without the prior written permission of Nanotron Technologies GmbH.

Copyright © 2007 *Nanotron Technologies GmbH*.

## Table of Contents

<b>1</b>	<b>Tomorrow's Wireless Communication Systems</b>	<b>1</b>
<b>2</b>	<b>Modulation Scheme Properties</b>	<b>2</b>
<b>3</b>	<b>MDMA: The Best of AM, FM and PM</b>	<b>3</b>
3.1	The Development of MDMA	3
3.2	Sinc Pulses and Chirp Pulses	3
3.2.1	Sinc Pulses	3
3.2.2	Chirp Pulses - Linear Frequency Modulated Signals	4
3.2.3	MDMA: Sinc Pulses and Chirp Pulses	5
3.3	AM, FM, and PM Contribution to MDMA	5
3.3.1	Contribution of Amplitude Modulation: Symbol Energy	6
3.3.2	Contribution of Frequency Modulation: Robustness	6
3.3.3	Phase Modulation	6
3.4	Channel Capacity	7
3.5	Increasing Data Rate with Chirp Pulses	8
3.6	MDMA Realized in Analog Circuits	9
3.7	Summary	9
<b>4</b>	<b>CSS: MDMA for Low Power Applications</b>	<b>10</b>
4.1	Resistance Against Disturbances	10
4.2	Robustness Against Multipath Fading	11
4.3	Summary	11
<b>5</b>	<b>nanoNET TRX: MDMA in Silicon</b>	<b>12</b>
5.1	Example Application	13
5.2	Possible Applications for nanoNET TRX	14
5.3	The Portable Protocol Stack (PPS)	14
5.4	The Advantages of PPS	15
5.5	nanoNET TRX Driver	16
	<b>Revision History</b>	<b>17</b>
	<b>About Nanotron Technologies GmbH</b>	<b>18</b>

Intentionally Left Blank

**Abstract**

Today, sophisticated wireless communication systems must guarantee:

- High quality transmissions
- Effective use of precious channel capacity
- Cost-effectiveness
- Low power consumption

Three well known modulation technologies – Amplitude Modulation or AM, Frequency Modulation or FM, and Phase Modulation or PM – can be combined into a universal and superior communication method called Multi Dimensional Multiple Access or MDMA.

MDMA can be adapted for applications with medium data rates and extremely low power requirements. This adaptation of MDMA is a wireless method called Chirp Spread Spectrum or CSS. nanoNET, which is based on CSS technology, allows the wireless communication of data that is very robust against electromagnetic disturbances and, most significantly, consumes extremely low amounts of power.

A major component of nanoNET is the Portable Protocol Stack or PPS. The PPS is modularly structured and can be ported to any common microcontroller platform without a large effort.

## 1 Tomorrow's Wireless Communication Systems

Sophisticated wireless communication systems have highly complex and partially contradictory requirements. For instance, the signals must be distributed over wide areas without loss despite the fact that the signal can be disturbed by other wireless systems and that multipath fading can effect the quality of the signal (that is, signals are reflected during transmission).

In the past decade, the continuously increasing use of wireless communication systems and wireless services has led to another urgent requirement. The precious channel capacity in the electromagnetic spectrum must be utilized as effectively as possible so that as many bits per second can be transmitted through overcrowded and expensive channels.

To meet these challenging requirements, an ideal wireless communication method should be robust and flexible to adapt bandwidth needs to the required transmission quality (Quality of Service). Furthermore, modern communication systems should have a low-cost and they should consume little energy (a requirement particularly important for mobile applications).

Additionally, the history of communication engineering shows a permanent evaluation of modulation schemes to meet the requirements of upcoming applications. The first technique developed was *Amplitude Modulation* or AM, but it is very sensitive to noise, so a second technique was developed to reduce this sensitivity. This is *Frequency Modulation* or FM, but it requires almost twice as much bandwidth as AM. With the advent of the digital age, *Phase Modulation* or PM was introduced to significantly reduce the required bandwidth as compared to that required by FM. But it too has to fight against disturbances and fluctuation of the carrier frequency.

## 2 Modulation Scheme Properties

The following tables provide the properties of Amplitude Modulation (AM), AM Single Side Band modulation (SSB), Frequency Modulation (FM), and Phase Modulation (PM).

### Amplitude Modulation (AM)

*Table 1: Amplitude modulation (AM)*

Required bandwidth B in the RF range for a bandwidth b in the baseband	Properties
$B = 2 b$	SNR dependent on amplitude

### AM Single Side Band modulation (SSB)

*Table 2: AM single sided band modulation*

Required bandwidth B in the RF range for a bandwidth b in the baseband	Properties
$B = 1 b$	Complicated due to the correct phase adjustment of the carrier in the RX; no IQ modulation

### Frequency Modulation (FM)

*Table 3: Frequency modulation (FM)*

Required bandwidth B in the RF range for a bandwidth b in the baseband	Properties
$B = 4 b$	Resistant, but requires large bandwidth

### Phase Modulation (PM)

*Table 4: Frequency modulation (FM)*

Required bandwidth B in the RF range for a bandwidth b in the baseband	Properties
$B = 2 b$	Susceptible to phase noise and other disturbances

### 3 MDMA: The Best of AM, FM and PM

Neither AM, FM, or PM are ideal as the benefits of each scheme are offset by its deficiencies. However, it is possible to build an ideal system that transmits information with a predetermined quality without wasting precious bandwidth. This can be done by intelligently combining these three modulation techniques into a single method – Multi Dimensional Multiple Access (MDMA). This method combines the best from each scheme in such a way that the sum becomes greater than its constituent parts.

#### 3.1 The Development of MDMA

Two basic considerations led to the development of MDMA:

1. Data should be transmitted from the transmitter to the receiver by the modulation of the carrier frequency (information).

Until now this task was taken by one of the three modulation schemes – either FM, AM, or PM, but each of these schemes demonstrates specific advantages and disadvantages.

2. The transmitted symbols must be adapted to their individual requirements and transmission conditions (transportation).

Initially, some general misunderstandings needed to be removed. For instance, the range of a signal is not dependent on its *power*; but rather a function of the *energy* supplied from the transmitter that enables the signal to reach the receiver. As an analogy, the distance a car can travel is dependent on the amount of fuel (energy) that is available to run the car's engine, and is completely independent from the horsepower of the engine. Thus, the main objective of communications engineering must be to apply exactly the correct amount of energy to each symbol to secure a successful transmission (which is based on the maximum acceptable Bit Error Rate or BER) without wasting precious bandwidth.

#### 3.2 Sinc Pulses and Chirp Pulses

MDMA uses two elementary signals for the processing and transmitting of symbols - Sinc pulses and Chirp Pulses. Both of these signals have partly complementary properties and have a special feature – they have an equal spectrum.

##### 3.2.1 Sinc Pulses

For baseband processing in the transmitter and receiver, ideal sinc pulses are deployed. These pulses have the shortest possible duration at a given bandwidth  $B$  ("Shannon-Limit", very small BT product of 1). Through this, the sequence of the bits in the baseband is optimal. Furthermore, *sinc* pulses are generated relatively easily in the transmitter and can be detected with a simple amplitude discrimination in the receiver.

The following illustration shows the sinc pulse in the time domain.

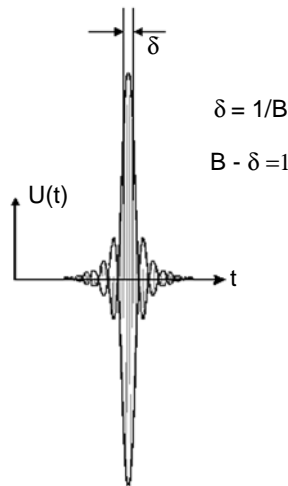

Figure 1: A sinc pulse in the time domain

The following illustration shows the sinc pulse in the frequency domain.

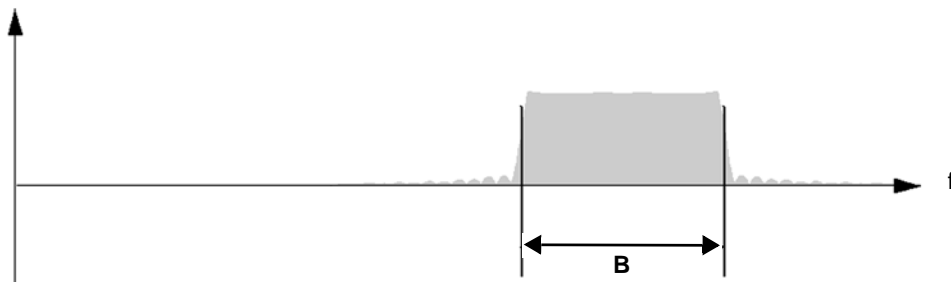

Figure 2: The spectrum of the sinc pulse in the frequency domain

### 3.2.2 Chirp Pulses - Linear Frequency Modulated Signals

MDMA uses chirp pulses for transmission over air. Chirp pulses are Linear Frequency Modulated (LFM) signals with a constant amplitude. They fill out the total available bandwidth  $B$  over a pre-defined duration  $T$ . A time-bandwidth product (BT product) can be realized that is much larger than 1. The larger is the time-bandwidth product, the more resistant the chirp pulses are against disturbances during transmission.

The following illustrates a chirp pulse (LFM pulse) in the time domain.

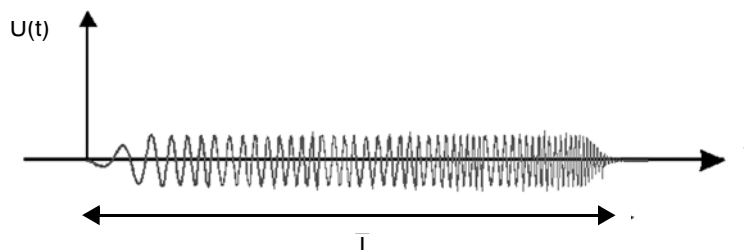

Figure 3: A LFM pulse in the time domain (Up Chirp)

The following illustrates a chirp pulse (LFM pulse) in the frequency domain.

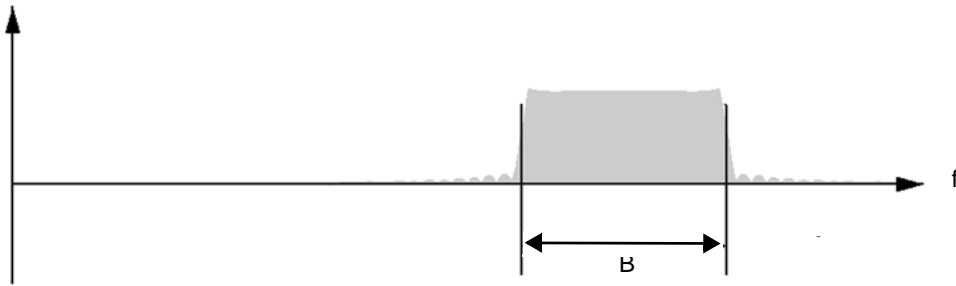

Figure 4: The spectrum of the LFM pulse in the frequency domain

### 3.2.3 MDMA: Sinc Pulses and Chirp Pulses

The same spectrum is not the only similarity of chirp and sinc pulses. These pulses can be simply and reversibly transformed from one into the other with a Dispersive Delay Line (DDL), for example, a SAW filter. The combination of these two signals form the basic principle of MDMA.

The following illustration shows the fundamental signal forms of MDMA.

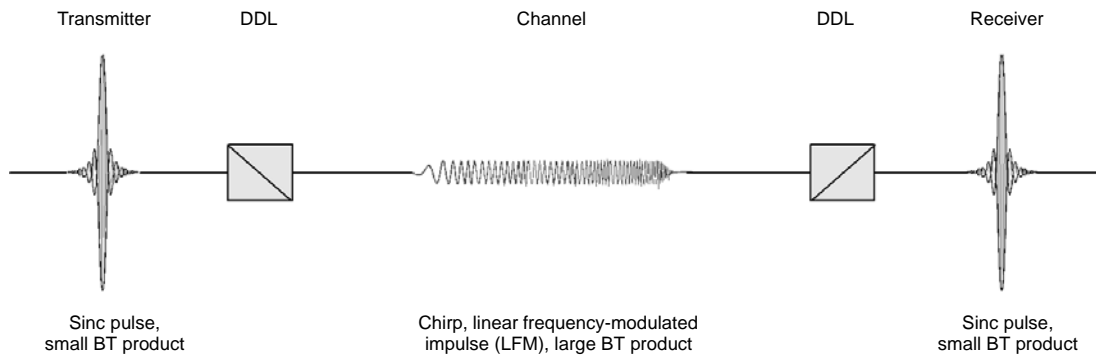

Figure 5: Signal forms of MDMA

### 3.3 AM, FM, and PM Contribution to MDMA

The following table lists the mathematical expressions of MDMA signals

Table 5: Pulses

Pulse	Expression
Sinc pulse (baseband)	$U(t) = U_0 \frac{\sin(\pi Bt)}{\pi Bt}$
Sinc pulse (RF band)	$U(t) = U_0 \frac{\sin(\pi Bt)}{\pi Bt} \cos(w_0t + \varphi)$
Chirp pulse	$U(t) = \frac{U_0}{\sqrt{Bt}} \cos\left(w_0t + \overbrace{\frac{ut^2}{2}}^{\text{PM}} + \varphi\right)$

The expression of the chirp pulse (which is distributed over the transmission channel) shows an integration of all three modulation schemes. The signal energy is defined as  $U_0$  with the Amplitude Modulation.

Each symbol uses the total available bandwidth  $B$  by Frequency Modulation (the character of the modulation scheme is expressed in the factor  $\mu$ ). The variable phase is utilized for the transmission of the information.

Each of the three modulation schemes makes a specific contribution to MDMA.

### 3.3.1 Contribution of Amplitude Modulation: Symbol Energy

The energy of the transmitted symbol is defined by the amplitude  $U_0$ . The amplitude can be adapted easily to the requirements for the transmission of the information (such as range and BER) during operation at the transmitter.

Thus, a higher BER for voice transmission can be accepted (using lower amplitude) than that required for important data (using higher amplitude).

### 3.3.2 Contribution of Frequency Modulation: Robustness

The modulation of the frequency guarantees robustness against disturbances.

- Amplitude fills the total available bandwidth: frequency spreading

The LFM pulse with constant amplitude fills the total available RF bandwidth  $B$ . Thus, MDMA always uses the total available bandwidth  $B$  of the channel for the transmission of information, even if the data rate does not require the full bandwidth. This technology is known as *Frequency Spreading*.

The spread factor is defined as bandwidth  $B$  divided by data rate  $R$ :

$$\nu = \frac{B}{R}$$

Narrowband noise does not effect the transmission of the symbol significantly because the full bandwidth of the RF channel is used. Enough uninfluenced symbol energy remains to reach the receiver.

- Signal passes the full bandwidth: time spreading

The second parameter that can be set is the duration  $T$  in which the signal passes the full bandwidth (duration  $T$  of the chirp pulse). This technology is known as *Time Spreading*. This is the duration  $T$  of the chirp pulse divided by shortest symbol duration:

$$\psi = \frac{T}{\delta} = BT$$

- Result: high resistance against disturbances

The effect of time and frequency spreading is a high *time-bandwidth product* and, consequently, the signal has a high resistance against disturbances (noise).

### 3.3.3 Phase Modulation

The actual *information* can be embedded in the signal using the phase. This becomes one of the major advantages of MDMA – the amplitude of the signal in the transmission channel is almost constant over time.

### 3.4 Channel Capacity

The constant conditions for any transmission system are the available bandwidth  $B$  within the electromagnetic spectrum and the maximal allowed transmission power  $P$ . They define the channel capacity  $C$  and should be used as optimally as possible so not to lose bandwidth at the pre-determined BER (Bit Error Rate).

MDMA shows its strength through the almost perfect spectrum of the chirp pulse (sharp edges on each side and flat in between). Thus, the available rectangle of bandwidth  $B$  and power  $P$  is almost completely filled (small shaping factor of almost 1). This results in a near optimal use of the channel capacity by chirp pulses.

The mode of function of the dynamic transmission scheme MDMA can be illustrated as an information cube:

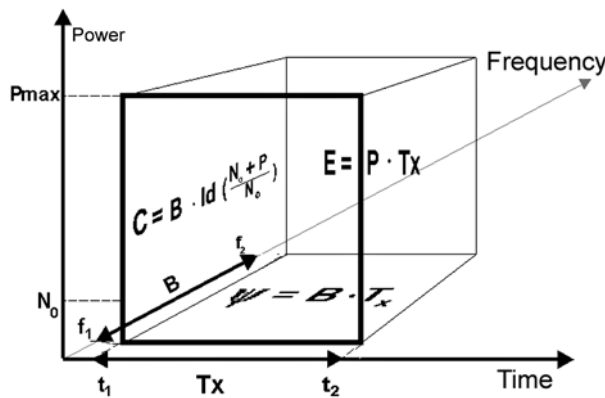

Figure 6: MDMA transmission scheme

The projection area on the side of the cube shows the channel capacity  $C$ , while the back of the cube shows the energy  $E$  out of the product of power  $P$  and time  $T$ . The base of the cube shows the time-bandwidth product.

The channel capacity according to Shannon is:

$$C = B \cdot \log_2 \left[ \frac{E_s + E_0}{E_0} \right] \text{ [bit / s]}$$

The amount of information  $I$  is the product of channel capacity  $C$  and time  $T$ .

$$I = \int_{t_1}^{t_2} C \cdot dt = B \cdot (t_2 - t_1) \cdot \log_2 \left[ \frac{E_s + E_0}{E_0} \right] \text{ [bit]}$$

The frequency spread that effects the bandwidth  $B$  is used with constant power density independently of the data rate (area  $C$ ). Furthermore, the power of the sinc pulse is evenly spread by the time spread in such a way that energy distribution (the transmission power) is almost constant over time. It fills out the energy area almost completely. According to this, the symbol energy (which can diversify due to the frequency spread) is distributed with the time spread.

The third area, the time-bandwidth product, reflects the dimension of the time spread. Keep in mind that the frequency and time spread is utilized to distribute the energy preferably over the whole volume of the information cube. Thus, double spreading allows the equal distribution of symbol energy over the information cube.

Thus, the symbol energy  $E_b$  is relevant for the safe transmission of symbols over a certain distance rather than the transmission power  $P_S$ . The symbol energy  $E_b$  is also crucial for the quality of the transmission.

### 3.5 Increasing Data Rate with Chirp Pulses

A very interesting possibility is to superpose a number of chirp pulses to increase the data rate. Chirp pulses can be superposed without problems as long as the total amount of transmission power  $P$  does not exceed the limit for the utilized frequency range. One of the strengths of MDMA is the ability of the requested transmission properties of the system to be optimally adapted by varying the amplitude  $U_0$ . The amplitude can be set to its permitted maximum in order to meet the extreme requirements of quality or range. The amplitude of the chirp pulses can be reduced for lower requirements by superposing many chirp pulses to increase the data rate. MDMA can be adapted dynamically to the required quality of service (Quality on Demand or QoD) and at the same time optimally utilizes the precious channel capacity.

The following illustration shows a single chirp pulse with duration  $T$  ( $P_{Chirp}=P_{max}$ ).

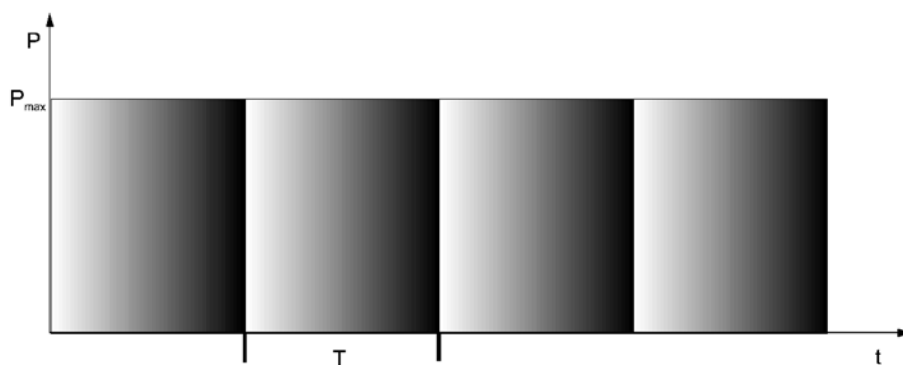

Figure 7: Single chirp pulse with duration  $T$  ( $P_{Chirp}=P_{max}$ )

The following illustration shows superposed chirp pulses with duration  $T$  and offset  $T/4$  ( $P_{Chirp}=1/4 P_{max}$ ).

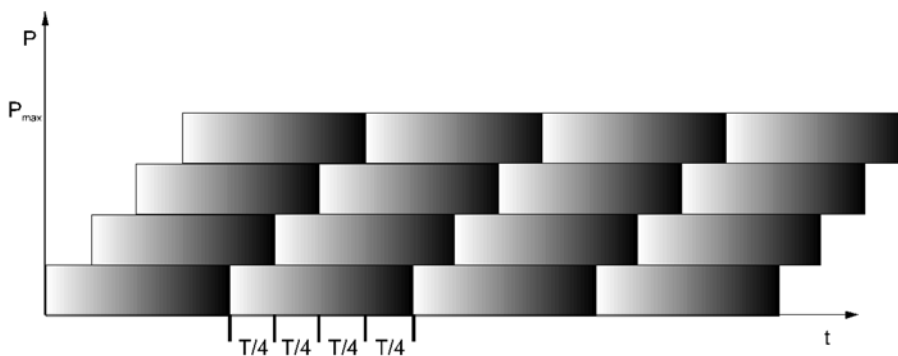

Figure 8: Superposed chirp pulses with duration  $T$  and offset  $T/4$  ( $P_{Chirp}=1/4 P_{max}$ )

### 3.6 MDMA Realized in Analog Circuits

The key properties of MDMA include its flexibility and robustness for wireless communication systems, but it has another valuable property – it can be realized in pure analog circuits with only minimal expensive digital technology.

The symbols are regained simply by amplitude discrimination in the receiver. This allows for the development of low cost and low power systems based on MDMA technology. With this method, the following conflicting requirements have been solved:

- High robustness
- High flexibility
- Quality at low cost
- Extremely low power consumption

### 3.7 Summary

MDMA fulfils the postulates for an ideal communication method by an extremely elegant combination of the three modulation schemes: frequency, amplitude, and phase modulation. MDMA is robust because of its wideband signal and optimal use of bandwidth. It can increase or decrease the data rate in the channel during operation according the requested BER. MDMA can be used in wireless communication systems such as wireless LAN, wireless local loop or even for the next generation of mobile phones because of its simple system architecture and low power consumption.

## 4 CSS: MDMA for Low Power Applications:

*Chirp Spread Spectrum* or *CSS* is the first and simplest application of MDMA technology. It is customized for the requirements of battery-powered sensor networks with high data rates. In such applications, reliability of the transmission as well as low power consumption are of special importance.

The following are the key features of CSS:

- CSS operates in the ISM band at 2.45 GHz
- Achieves a maximum data rate of 2 Mbps.
- Each symbol is transmitted with a chirp pulse that has a bandwidth of 80 MHz (an effective bandwidth of 64 MHz is the result of a selected roll-off factor of 0.25) and a fixed duration of 1  $\mu$ s.
- The system gain of CSS is 17 dB.

CSS does not take full advantage of the flexibility of MDMA (no superposition of chirp pulses) to keep the system design as simple, cost-effective and power-saving as possible.

The frequency and time spread of CSS are, as a special case of MDMA, equal to:

$$\nu = \psi$$

CSS can be implemented very simply without complex digital technology (digital signal processing). The creation and processing of the signals takes place in the analogue domain which results in a very simple and a very cost effective implementation.

### 4.1 Resistance Against Disturbances

Because CSS uses broadband chirp pulses, it is very resistant against disturbances. The following diagram shows the effect of narrowband noise with a signal-to-noise ratio (SNR) of 0 dB:

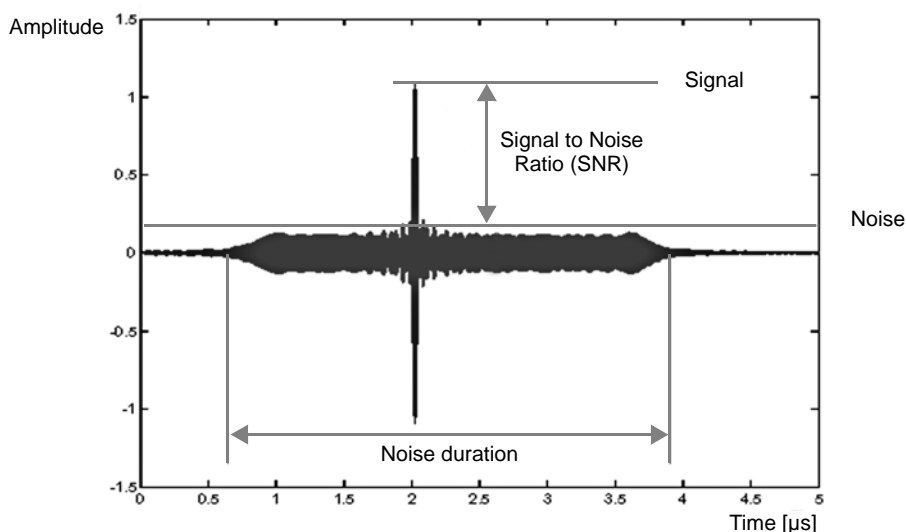

Figure 9: Narrowband noise with a signal-to-noise ratio (SNR) of 0 dB

The signal is reinforced by the dispersive delay line (DDL) while the disturbances contribute only as basic noise (system gain). Therefore, CSS is very resistant against narrowband noise.

CSS is resistant even against broadband disturbances. The diagram below shows the effects of broadband disturbances at SNR of 0 dB. The DLL effects a significant reduction of the noise with respect to the signal.

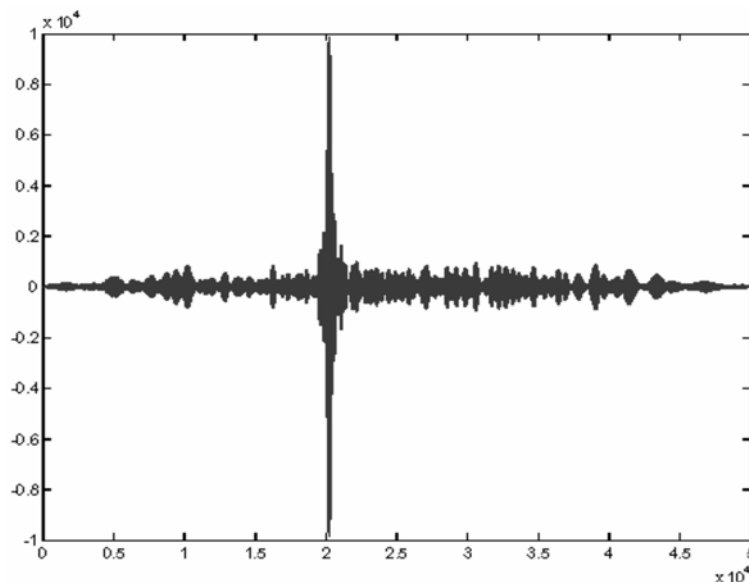

Figure 10: Broadband disturbances at SNR of 0 dB

With this, CSS is most suitable for the highly used ISM band where interference from other communication services and microwave ovens create massive disturbances.

## 4.2 Robustness Against Multipath Fading

Another significant advantage of CSS is its robustness against multipath fading. The original signal from the transmitter reaches the receiver with several echoes and reflections from buildings and other environmental surroundings due to multipath propagation. The reflections reach the receiver in or out of phase. Some frequencies will be amplified or attenuated depending on the conditions. This leads to a disconnection of the communication link of narrowband transmission systems. CSS is different, however, in that the amplified and attenuated signals are in balance because all energy shares (which are spread over the bandwidth of 80 MHz) are collected (integrated broadband technique).

## 4.3 Summary

The use of the robust chirp pulse in CSS significantly reduces the required transmission power that is needed for transmission over a given distance. This reduces the human exposure drastically ("electro smog"). No scientific research has proven the negative effects of electromagnetic exposure for human beings but the public acceptance for new wireless services with less transmission power will increase.

## 5 *nanoNET TRX: MDMA in Silicon:*

nanoNET TRX is the first implementation of Nanotron's MDMA technology into silicon and is the first RF transceiver device based on CSS technology. This transceiver is the simplest form of MDMA and operates in the ISM band at 2.45 GHz.

The key features of the nanoNET TRX include:

- A chirp impulse with a bandwidth of 80 MHz and 1  $\mu$ s duration is used to transmit a symbol
- Provides a maximum data rate of 2 Mbps.
- Achieves a range of up to 900 meters in free space and approximately 60 meters indoors at a transmission power of 10 mW and a gross BER (Bit Error Rate) of  $10^{-3}$ .
- The output power is -25 dBm to +10 dBm.
- The receiver sensitivity is -92 dBm @ BER= $10^{-3}$ .
- Supply voltage is 2.4 to 3.6 V (unregulated).
- The available channel capacity is utilized nearly 100 percent.
- The current consumption of the system is about 40 mA for reception and 86 mA for transmission at 10 mW transmission power. The main reason for *nanoNET's* low power consumption is a low duty cycle due to the high physical data rate and the absence of power-consuming digital signal processing for echo reduction or error correction. This reduces the system cost as well.
- The power consumption in standby mode is about 1  $\mu$ A. Thus, the battery lifetime can be many years.
- The integrated MAC controller supports ALOHA, CSMA/CA (Carrier Sense Multiple Access/ Collision Avoidance) and TDMA (Time Division Multiple Access). Thus, any common, low-cost microcontroller can be used for the system because all time critical tasks are embedded in the device.
- The communication between the *nanoNET TRX* and the microcontroller takes place via a standard SPI interface (Serial Peripheral Interface). Very few external components are required to develop a complete wireless communication node.
- Provides a high system gain of 17 dB.
- Includes four channel digital I/O (bidirectional), as well as a standard SPI interface to an external microcontroller.
- Temperature range for using the chip is from -40°C to +85°C.
- Integrated real time clock (RTC) and integrated power management.

### 5.1 Example Application

The following application is an example of the *nanoNET TRX Transceiver* used with a temperature measurement and control device.

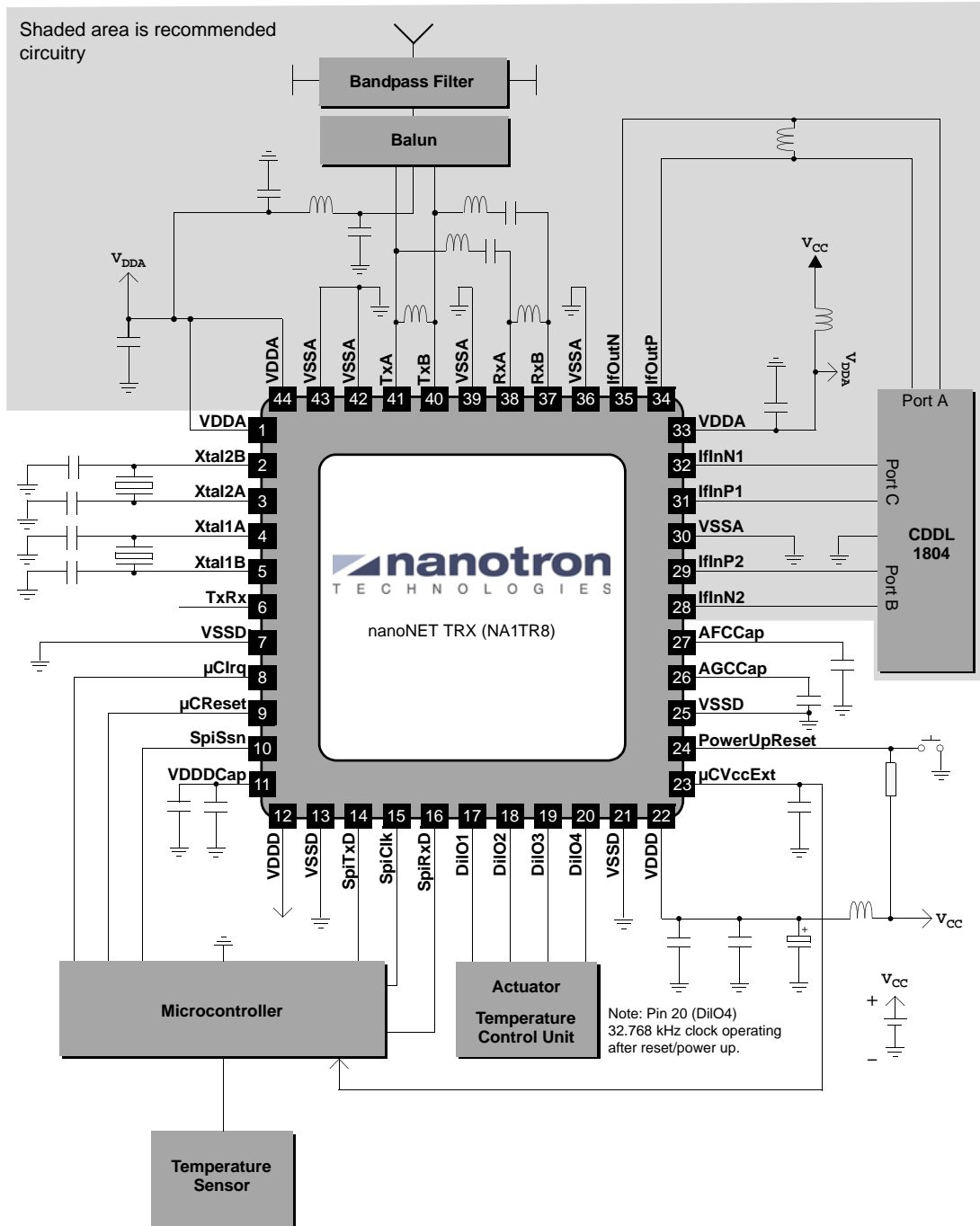

Figure 11: Example application showing recommended circuitry

A node using the *nanoNET TRX Transceiver* consists of the transceiver, an external CDDL, a microcontroller, and software. The effort for system development is low due to this high level of integration. Consequently, development time and costs are reduced for each node. Furthermore, the software, *Portable Protocol Stack* written in C, supports all common microcontrollers. *Nanotron Technologies* supplies all components except for the microcontroller.

## 5.2 Possible Applications for *nanoNET TRX*

Many applications can take advantage of the technological properties of the *nanoNET TRX*. The following are a few representative applications:

### Factory automation

A visible trend can be recognized in this market to connect sensors and activators with each other wirelessly to reduce costs and to increase the reliability of equipment. The worldwide market for factory automation is growing annually by about 10 percent and the segment for wireless solutions is growing even faster. In particular, the requirements for robustness and wide operating range under difficult conditions makes *nanoNET TRX* very interesting for this market.

### Intelligent Access Control

Sensitive areas in offices and buildings can be protected with wireless keys (for example, in smart cards). This has become more important since the terrorist attacks against the US. Because wireless keys require long battery lifetime, this represents an enormous opportunity for *Nanotron's* technology.

### Active RFID

Humans, animals and goods can be wirelessly identified with active RFID. Wireless logistic tags have a much wider range and can be re-programmed when compared with passive systems. MDMA's robustness, low energy consumption and low price presents an attractive solution. It might be possible to realize an active RFID system at the same cost as today's passive solutions.

### Alert Systems

Typical alert systems consist essentially of a base station and several sensors (for example, fire or movement sensors). The requirements for robustness are extremely important for such professional use. Bi-directional communication allows frequent testing of the complete system. Currently, wireless alert systems are not widely accepted for professional use. This represents another excellent opportunity for *Nanotron's* technology.

### Communication between Peripherals and PC

A clear trend in the computer market is the wireless connection of PC peripherals (for example, mouse, printer, and PDA). More and more peripherals require higher data rates. The limitations of Bluetooth™ include a limited number of nodes per network (up to 8 nodes), relatively high power consumption and limited data rate (below 1 Mbps). *nanoNET TRX* is perfectly suited for this task because of its unlimited number of nodes, higher bandwidth, low radiation, low cost, and low power consumption.

## 5.3 The Portable Protocol Stack (PPS)

A major component of *nanoNET TRX* is the *Portable Protocol Stack (PPS)*, which was developed by *Nanotron Technologies*. The PPS is modularly structured and can be ported to any common microcontroller platform without a significant effort. It supports any established operating system or it can run stand-alone. The microprocessor is relieved from heavy workload due to the high grade of integration of functions into both the transceiver chip and in the PPS (for example, packet forwarding/switching and TDMA management). Thus, using the *nanoNET TRX* transceiver and the PPS software for a wireless product requires only a short development time which leads to reduced development cost and quick market entry (time to market).

The PPS provides a high-level C language application programming interface that is encapsulated in the Application Interface Layer or AIL. An application uses the AIL to control a *nanoNET* station and to send and receive wireless messages with other *nanoNET* stations.

The PPS also provides services that the application may use. These include buffer management, timers and other standard C library functions.

The PPS is accompanied by example applications and a full set of documentation which fully explains the process of creating or modifying an application to run with the PPS.

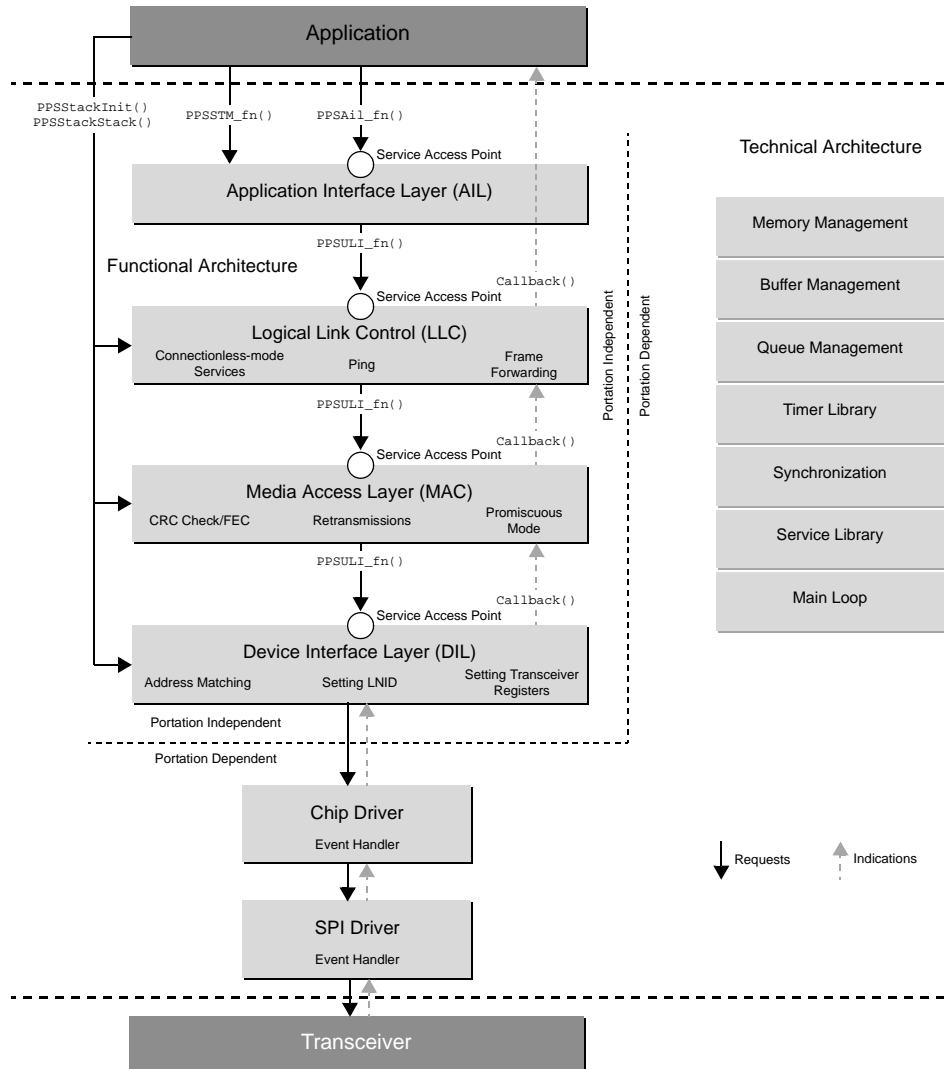

Figure 12: Overview of the Portable Protocol Stack

## 5.4 The Advantages of PPS

The advantages of building your solution with the PPS are many and include:

- A comprehensive set of functionality that greatly reduces the effort for the design, implementation, and testing of a target solution.
- An application interface with a high-level functional interface, rather than a specific nanoNET TRX Chip interface.
- PHY and MAC layer support functions are provided in a universal form.
- Comprehensive Logical Link Control capabilities that allow the operation of:
  - Applications directly over the Logical Link Control interface
  - Communication protocols over the PPS, for example TCP/IP or LON

- The support of complex (wireless) nanoNET network topologies that are transparent to the application.
- Flexibility to choose from a wide variety of target systems as the PPS is:
  - Independent of target CPUs (for example, 8/16/32-bit CPUs)
  - Independent of target system architectures
  - Independent of target operating system and software environments
- Clearly defined, flexible architecture that allows backward compatible functional extensions in the future.
- High maintainability, as the integration of updated and/or upgraded functional elements is possible without repeating core portation tasks.

For further information about the nanoNET Portable Protocol Stack, refer to the *nanoNET PPS White Paper*.

## 5.5 nanoNET TRX Driver

This nanoNET TRX Driver is referred to within the source code as the *Device Interface Layer, or DIL*, as it provides a convenient interface for upper layers and applications to interact with the transceiver.

This driver is used by applications to send MAC layer messages to the nanoNET TRX Transceiver over the SPI interface. It provides settings based on specific chip versions and on performance criteria such as address matching, error checking, modulation methods, and data transmission rates.

The delivered source code can be easily ported to any microcontroller environment for which a C compiler is available. Depending on the portation, the nanoNET TRX Driver may operate synchronously or asynchronously, blocking or non-blocking, and with or without queues. Practically any architecture or strategy can be used in the nanoNET TRX Driver.

## Revision History

Date	Version	Description/Changes
2004-01-12	1.01	Initial version from Marketing.
2004-12-02	1.02	Initial version from R&D Documentation
2005-10-18	1.03	Minor textual changes; new template applied; company address updated.
2007-02-20	1.04	nTRX Driver section added, minor editing, updated sample application added.

---

## About Nanotron Technologies GmbH

Nanotron Technologies GmbH develops world-class wireless products for demanding applications based on its patented Chirp Spread Spectrum – an innovation that guarantees high robustness, optimal use of the available bandwidth, and low energy consumption. Since the beginning of 2005, Nanotron's Chirp technology has been a part of the IEEE 802.15.4a draft standard for wireless PANs which require extremely robust communication and low power consumption.

ICs and RF modules include the nanoNET TRX, the nanoLOC TRX, and ready-to-use or custom wireless solutions. These include, but are not limited to, industrial monitoring and control applications, medical applications (Active RFID), security applications, and Real Time Location Systems (RTLS). nanoNET is certified in Europe, United States, and Japan and supplied to customers worldwide.

Headquartered in Berlin, Germany, Nanotron Technologies GmbH was founded in 1991 and is an active member of IEEE, the ZigBee alliance, and ISA-SP100.

### **Further Information:**

For more information about this product and other products from Nanotron Technologies, contact a sales representative at the following address:

Nanotron Technologies GmbH  
Alt-Moabit 60  
10555 Berlin, Germany  
Phone: +49 30 399 954 - 0  
Fax: +49 30 399 954 - 188  
Email: [sales@nanotron.com](mailto:sales@nanotron.com)  
Internet: [www.nanotron.com](http://www.nanotron.com)